



FTC GLOBAL
CENTRAL VACUUM SYSTEMS

POWERFUL SUCTION AND
UNMATCHED FILTRATION
FOR THE **CLEANEST HOME**



CENTRAL VACUUM CLEANING SYSTEMS

A preferred choice of electrical pros.

FTC Global central vacuums combine powerful suction and HEPA filtration to:

**CREATE A HEALTHIER,
CLEANER ENVIRONMENT
FOR YOUR FAMILY.**



Central Vacuum Clearer System

Fresh Healthy Comfort Quiet



Features

- 🔊 Quiet life: the host away from the living space, when using noise-free, quiet home leisurely.
- 💧 Clean and efficient: removal of harmful micro-organisms, mites, pollen, pet dander and other dust materials for more than 0.3 microns, the efficient rate up to 99.7% .
- 🔄 Fresh and health: the dust stored in the host through the pipeline, separate vacuum, the exhaust process to prevent secondary pollution, so that can make indoor and outdoor spacekeep fresh and healthy
- 🔄 Light use: to insert a vacuum hose valve can be remote control host, professional self-cleaning filtration system to reduce the use of cost.
- 🔄 Engineer-moving system: The vacuum cleaner by the AMETEK LAMB of United States is about 5 times as the ordinary cleaner, can meet the variety needs of all environmental conditions.



Engineer-moving system: The vacuum cleaner by the AMETEK LAMB of United States is about 5 times as the ordinary cleaner, can meet the variety needs of all environmental conditions.

- 🐾 Pet clean: effective removal of bacteria, microbes, dust and pet dander and so on .
- 🏠 Building clean: It can be widely applied to remove dust in residential, hotels, hospitals, offices, factories, etc.
- 🔧 Object clean: with all kinds of interfaces used in automobiles, computers, pets, radiator, carpet, floor. sticky dust cloth and other special items.



Traditional Vacuum cleaner compare with Central Vacuum cleaner system

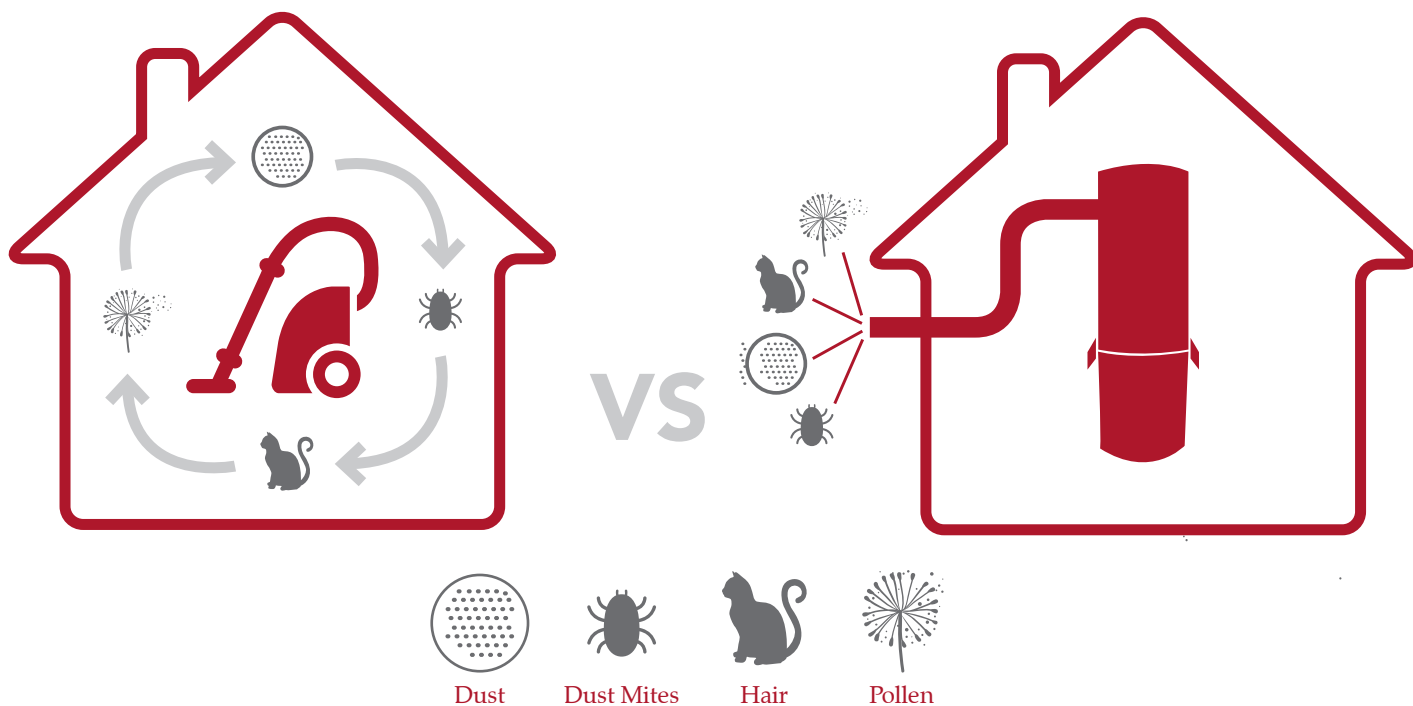

	The Traditional Vacuum cleaner	Central vacuum cleaner system
Noise	The indoor noises reach to 70-80DB, it will affect you and your family's normal life.	The host equipment is far way from the living area, there have no noise when in use, just slight sound of air.
Cleaning Efficiency	Electrical power is small, air tightness is not enough, small suction, it can't clean the micron-level indoor pollution particles thoroughly, only 50-micron filter is the smallest particles, can not fight the mites in the living room.	The cleaning efficiency is 5-8 times as the traditional vacuum cleaner, guarantee filter at least 99.97% of 1 micron and above dust.
Second Pollution	The tiny dust which is sucked into the vacuum cleaner will re-cycle emission into the indoor air, cause the secondary pollution.	The dust will all sucked through the conduit to the host, emission outdoor. It will not cause secondary pollution on you and your neighbor.
Operation	There will have some troubles when the vacuum host in use, sometime the trouble is due to the wire is not long enough, every use, the machine was drag back and forth, easy abrasion the ground and collide the furniture.	When put the vacuum hose into a vacuum cleaning board, let the system automatic start. Or use the finger open the button which is in the vacuum hose handle so as to control the host's switch. The standard and special made hose full of flexibility , not abrade the decoration and furniture.
Daily Cleaning	The filter bag have small capacity, and the gathering dust particles easy to leave out.	The filter capacity is big, airproof, only need to dump 2-3 times per year; the clean method have little difference according to the different machine type.
Using Life	The electrical machine and the dust easy to combine, then begrime, It lead to the life shortened greatly.	Dedicated and highly efficient motors, motor and put an end to the dust exposure, So that the motor lasting life.
Healthy	Low filter precision, secondary pollution and so on these can't be eliminated harmful bacteria and emission also will cause all kinds of allergy and respiratory disease and so on syndrome, especially have a more great impact on elder and children.	Could efficiently removal and deduce the harmful contaminations of the air, provider your whole family a breath easy, healthy indoor environment.

THE VALUE OF FTC GLOBAL CENTRAL VACUUM SYSTEM.



BENEFITS to the Homeowner

Our Central Vacuums combine powerful suction and unmatched filtration, to remove dust and other allergens from your home. Central vacuums exhaust the vacuumed air outside of your home unlike a traditional vacuum that recirculates air back into your living area.

MORE CLEANING POWER

Central vacuums are more powerful than upright and canister systems, they pull the dirt and dust out of carpets and upholstery.

BEST DUST FILTRATION

By exhausting the dirt and dust outside of your home, central vacuums provide you the cleanest indoor air.

QUIET

With the central vacuum power unit mounted in the basement, garage or utility area, the noise is away from your living area.

BUILT-IN CONVENIENCE

The lightweight hose is all you have to carry upstairs or from room to room. No heavy canister or upright vacuum to lug around.

GOOD INVESTMENT

Increase the resale value of your home without investing much more than the cost of a portable vacuum.

BENEFITS to the Builder

DON'T JUST BUILD A HOME

- **Make your homes stand out from the rest in today's competitive market** – Offer your home buyers a quieter, cleaner, healthier home with a central vacuum that removes pollutants from the house
- **Increase the value of your homes** – Dollars spent installing a central vacuum system is considered by appraisers to increase a home's value
- **Earn points towards Green Building Certifications** from Organizations like Earth Advantage®, Environments for Living®, and the US Green Building Council with its LEED® Rating System

BENEFITS to the Installer

ADD VALUE AND CONVENIENCE

- One unit gives bagged and bagless options – reduce inventory costs and stock just 1 SKU for bagged and bagless customer requirements
- One bag fits all power units
- Easy to install – **Multi-direction** vacuum connection for easy installation even in small spaces
- Each model includes a **wall mount bracket** for safe and simple installation
- Offer exceptional value to your builders and homeowners

SYSTEM PLANNING – NEW OR EXISTING CONSTRUCTION

INSTALLATION

Each Central Cleaning System comes packed with a Planning & Installing Guide. Whatever your home layout – multi-level, two-story or ranch – we have a system to meet your needs. As few as three or four inlets can take care of an average size home. Once you've determined the right system for you, a typical system can be installed in a day or less. Just choose whether you want to do-it-yourself or hire a professional installer.

FOR NEW CONSTRUCTION

Installation is simple! Plan the location of the power unit and inlets with your builder or contractor. Tubing, inlets and electrical hook-up can be made before drywall, plaster or finished flooring is in place. You can even “pre-tube” your home, then select and install the power unit later!

FOR EXISTING CONSTRUCTION

Just determine the number and location of inlets and cutting through drywall can be kept to a minimum. Tubing can be run through cold air returns, closets and stairwells.

NOTE: Our Central Cleaning Systems are not designed for wet pick-up.



WALL INLET PLANNING

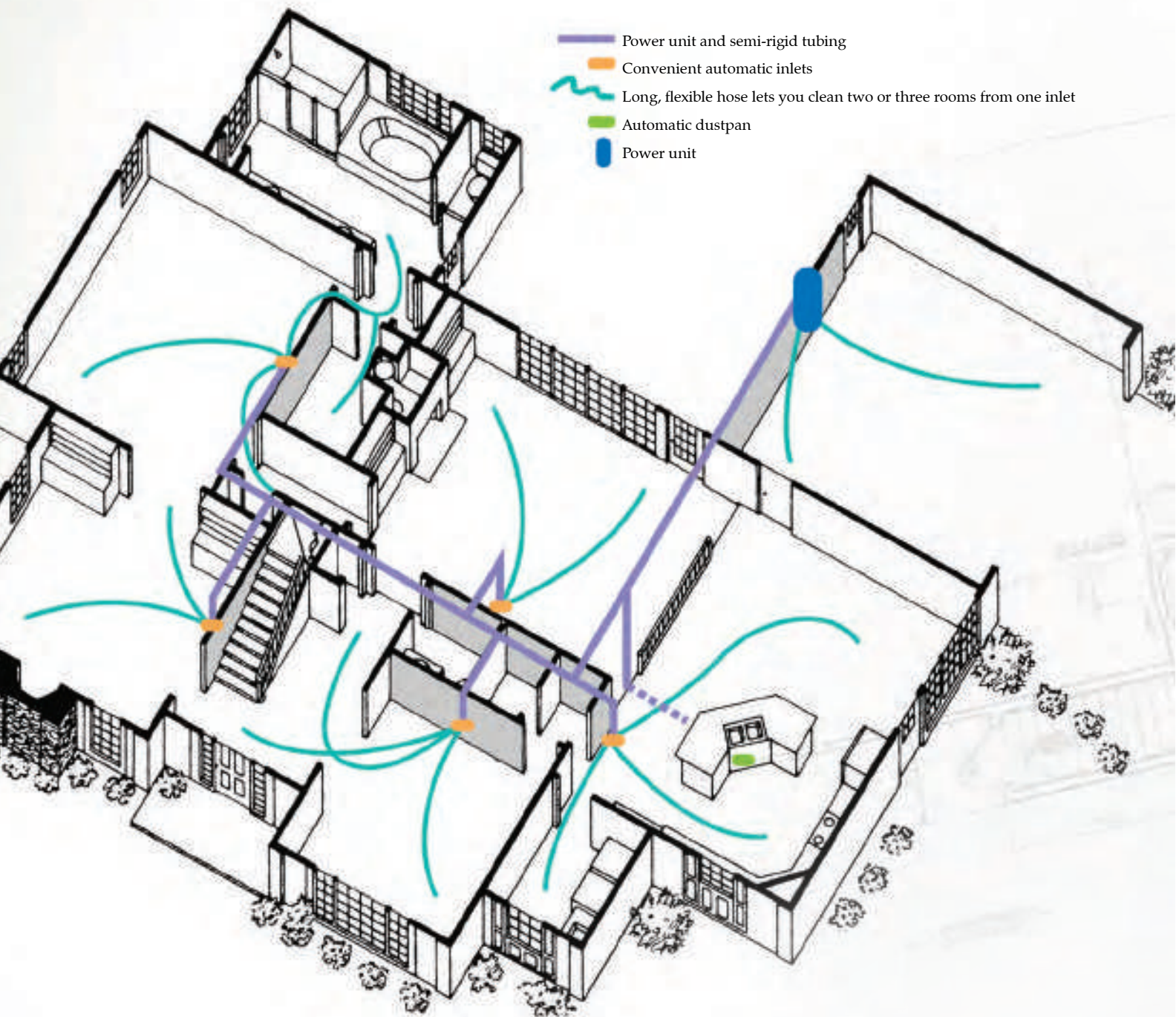

In other floor plans, the power unit may be located in the basement, laundry or utility room.

Average size 3 or 4-bedroom homes may be adequately serviced with 3 or 4 inlets plus the power unit. Utility inlets can also be used on patios and porches or in garages.



CVS3.12
CVS3.16

CVS3.12 / CVS3.16

Efficient cleaning: the suction ability is many times as the normal vacuum.

No second pollution: Drain the gas out of the room directly.

Low noise: The host adopt OUODE silent technology

Simple operation: The vacuum faucet around everywhere, convenient to vacuum.

Intelligent and energy: Have special MENRED control system

Easy- mounting: It is easy to mount when built or decorate the house.

Electric machine: Imported motor;

Dust collection barrels:

Visible window, easy to check the amount of dust which is absorbed

Filters:

Install the host, do no affect the disassemble dust collection barrel;

The vent of electric machine:

Security Configuration, promoting electrical life.

High-performance muffler:

The host have High-performance muffler which is developed by Manderi, run in super silent.

Hasp-style dust collection tank to open means: The operation to maintain life-long seal is more portable, user-friendly open;

Nami self-cleaning filter bags: dealing with self-cleaning nami-technology structural design, the low- cost use, environmentally and energysaving.



Black
CVS3.12
CVS3.16



Blue
CVS3.12
CVS3.16



Yellow
CVS3.12
CVS3.16

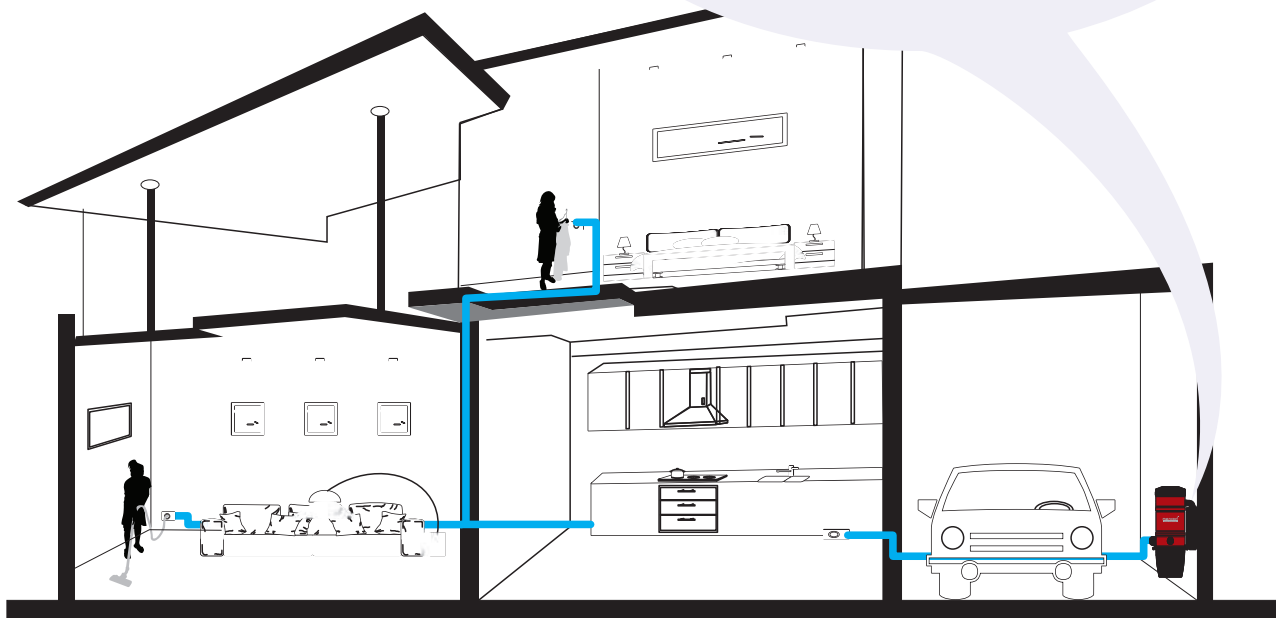

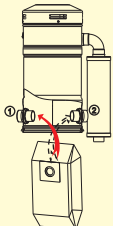
Model	CVS3.12	CVS3.16	CVS3.16 (stainless steel only)
Category	Hybrid Cyclonic		
Power Unit Crus	Imported steel plate		
Motor	Worldwide top brand For vacuum motor		
Power (W)	1300	1600	1800
Voltage (V)	230		
Water Lift (H ₂ Omm)	2550	3000	3600
Discharge(H ³)	170	170	210
Utility Inlet	YES		
Motor protection system	YES		
Muffler	Outward Aluminium Muffler		
Capacity (L)	20		
Weight (Kg)	13		
Size(mm)	φ 280 × 910		
Sound Level(3m)(db)	58	61	61
Motor Warranty	3 Years		
Filtration System(1)	 <p>Self Cleaning</p> <p>Filtration system Nano-Filtration System:</p> <ul style="list-style-type: none"> > Self-cleaning function > Durable > No Replacement > No usage cost 		
Filtration System(2)	 <p>1.If the air vent at ①, please connect the filter bag to ①, and close the ② air vent by pipe cap. If the air vent at ②, please connect the filter bag to ②, and close the ① air vent by pipe cap.</p> <p>2.When find the suction decreasing in using, please check the filter bag full or not, if it's full, please change the bag to protect the whole vacuum clean system operate well.</p>		

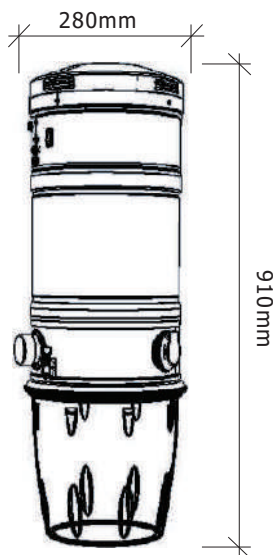

Package Size:
415 × 415 × 995mm

Standard Accessories

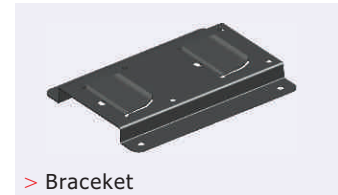

> Bracket



> Hose



> Outlet air vent

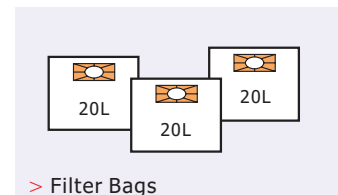

> Filter Bags



> pipe collar clamp



> 90° Degree elbow



> Muffler



> User Manual

CVS3.12R501/ CVS3.12R502



Red
CVS3.12
CVS3.16

Features

- > Working in silence
- > Around inlet and exhaust arbitrary choice
- > Fine filter filtration rate was 99.7%, the filtering effect of small dust excellent cleaning efficiency
- > Easy to use, as long as a year to replace filters once or twice, sanitation and hygiene.
- > Appearance of compact, small size, easy installation, can be installed in the kitchen cabinets inside.



Yellow
CVS3.12R501
CVS3.12R502



Blue
CVS3.12R501
CVS3.12R502



Black
CVS3.12R501
CVS3.12R502

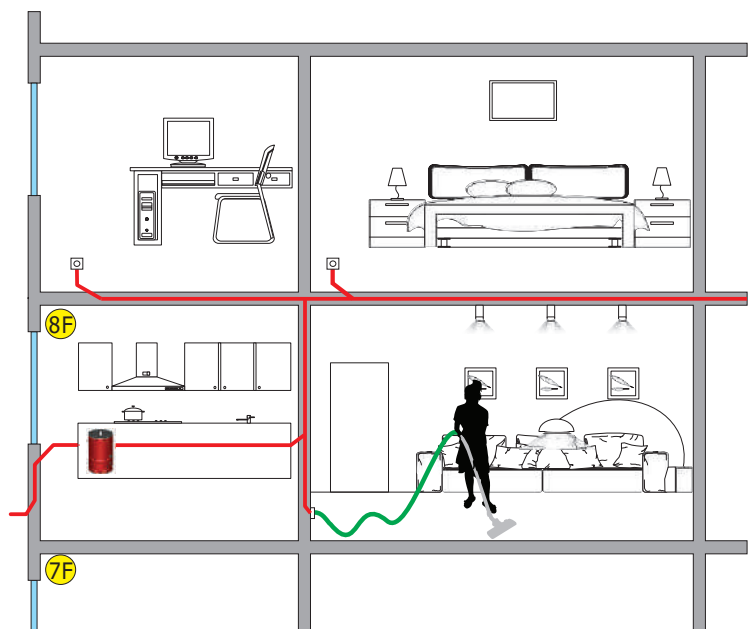

Model	CVS3.12R501	CVS3.12R502
Category	Hybrid Cyclonic	
Power Unit Crus	Imported steel plate	
Motor	Worldwide top brand For vacuum motor	
Power (W)	1300	1600
Voltage (V)	230	
Water Lift (H ₂ Omm)	2500	2800
Discharge(H ³)	165	180
Muffler	Outward Aluminium Muffler	
Capacity (L)	20	
Weight (Kg)	9.5	
Size(mm)	φ 280 × 450	
Sound Level(3m)(db)	56	
Motor Warranty	3 Years	
Filtration System	 <p>Nano-Filtration System:</p> <ul style="list-style-type: none"> > Easy to clean > Easy to maintain > Good air permeability > Easy to change 	

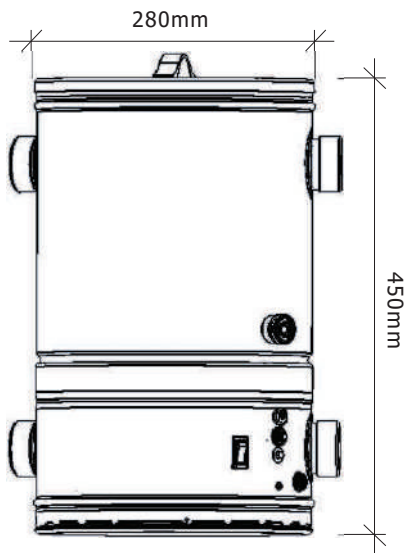

Package Size:
412 × 412 × 565mm

Standard Accessories

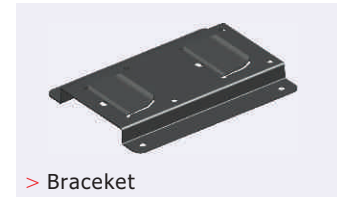

> Bracket



> Hose



> Outlet air vent

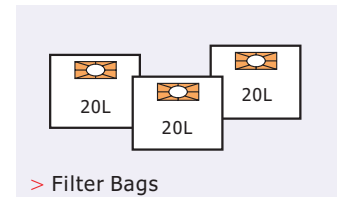

> Filter Bags



> pipe collar clamp



> 90° Degree elbow



> Muffler



> User Manual

ATTACHMENT SETS



CS600

Carpet & Bare Floor Combination Electric Direct Connect Attachment Set

- CT105 – Natural Hair Dusting Brush
- CT110 – Long Crevice Tool
- CT106G – Natural Hair Upholstery Tool
- CK135 – Ratcheting Wand
- CT158 – Premium Twist & Turn Floor Brush
- CT175 – Current Carrying Ratcheting Wand
- CT700 – Deluxe Electric Powerhead
- CH615 – Current Carrying Direct Connect Crushproof Hose
- CA130 – Hose Sock
- Hose Hanger
- Wand Hanger
- Mesh Storage Bag



CS500

Carpet & Bare Floor Combination Electric Pigtail Attachment Set

- CT105 – Natural Hair Dusting Brush
- CT110 – Long Crevice Tool
- CT106G – Natural Hair Upholstery Tool
- CK135 – Ratcheting Wand
- CT158 – Premium Twist & Turn Floor Brush
- CT175 – Current Carrying Ratcheting Wand
- CT700 – Deluxe Electric Powerhead
- CH515 – Current Carrying Pigtail Crushproof Hose
- CA130 – Hose Sock
- Hose Hanger
- Wand Hanger
- Mesh Storage Bag



CS400

Carpet & Bare Floor Combination Air Turbine Pet Care Attachment Set

- CT105 – Natural Hair Dusting Brush
- CT110 – Long Crevice Tool
- CT106G – Natural Hair Upholstery Tool
- CK135 – Ratcheting Wand
- CT158 – Premium Twist & Turn Floor Brush
- CT350B – Air Turbine Brush
- CT109 – Pet Brush
- CH235 – 30' Crushproof Hose
- CA130 – Hose Sock
- Hose Hanger
- Wand Hanger
- Mesh Storage Bag



CS300

Bare Floor Attachment Set

- CT105 – Natural Hair Dusting Brush
- CT110 – Long Crevice Tool
- CT106G – Natural Hair Upholstery Tool
- CK135 – Ratcheting Wand
- CT158 – Premium Twist & Turn Floor Brush
- CH235 – 30' Crushproof Hose
- CA130 – Hose Sock
- Hose Hanger
- Wand Hanger
- Mesh Storage Bag



TREAT YOUR CARPET TO LONGER LIFE

with a wide selection of deep cleaning brushes.

The Electric Power Brush saves time and energy, while prolonging the life of your carpet. And, with easy-to-use touch-of-the-toe levers, you won't break your back bending to switch carpet heights and removing wands.

The turbine brush uses the airflow of the Central Vacuum System to remove dirt without the need for an electrical plug. It offers the perfect cleaning solution for low pile carpet and area rugs.

In addition, We offers a wide selection of cleaning accessories to enhance the versatility of your Central Vacuum System. From electric power nozzles for deep cleaning to standard tool sets with attachments for those hard to reach areas, we make all of your cleaning chores easier.

Electric Power Brush



CT700

Deluxe Electric Power Brush



This deluxe electric 14" power brush provides greater cleaning coverage without the extra work.

Features:

- Exceptional soil removal
- Maximum maneuverability and ease of use
- Superior LED lighting
- Four position height adjustment
- Dual edge cleaning with protective bumper
- Non-marking, rubberized coated wheels for improved traction



The CT700 features convenient height adjustment and brush release pedal options along with a multi-directional steering element for those difficult-to-reach areas.



Turbine Brush



CT350B

Air-Driven Turbine Brush

Lightweight yet powerful, NuTone's® CT350B turbine removes up to 38% more embedded soil than other turbine brushes. This design features a suction shoe that allows 45 degree pivot while in use and a full 360 degree swivel neck.

Features:

- Cog belt drive agitator brush
- Chevron pattern, nylon tufted agitator bristles
- Vacuum release valve opens and closes
- Rubber wheels

BRUSH SELECTION CHART

Model No.	Description	Color	Wands	Height Adjustments	Width	Headlamp	Belt Style	Edge-Cleaning
CT700	Deluxe Electric Power Brush	Gray	CT170 or CT175	4-position	14"	LED	Cogged	Dual
CT350B	Air-Driven Turbine Brush	Black	Sold Separately	No	11"	No	Cogged	Dual

ACCESSORIES



CT132

Chrome Button Lock Wands

Set of two chrome plated steel wands feature secure button-lock fit.



CK135

Ratcheting Wand

One-piece ratcheting wand extends from 22" to 39" at one-inch intervals. Positive ratchet mechanism locks into place. Durable chrome plated steel with button locks.



CT170

Adjustable-Ratcheting Electric Wand

Easily adjustable, one-piece ratcheting wand extends from 26" to 39" at one-inch intervals. Positive ratchet mechanism locks into place.

Use with CT700 power nozzle and "20" series hoses.



CT175

Direct Connect Adjustable-Ratcheting Electric Wand

Easily adjustable, one-piece ratcheting wand extends from 26" to 39" at one-inch intervals. Positive ratchet mechanism locks into place.



CT105

Dusting Brush

Soft natural bristles provide gentle cleaning for delicate surfaces. Fits onto all wands.

Black.



CT106G

Upholstery Tool

Provides deep cleaning, with or without the slide on natural bristle brush. Fits onto all wands. **Black.**



CT109

Pet Brush

Hard plastic tool with nylon brush provides gentle grooming. Fits onto all wands. **Black.**



CT110

Long Crevice Tool

Gives you added reach to clean hard-to-reach areas. Clipped end provides continuous air flow. Fits onto all wands. **Black.**



ACCESSORIES (continued)



CT140G

Standard Floor/Rug Tool

Wide 10-5/8" head. Pedal automatically adjusts as you move from hard surface to carpet and dual rear wheels ensure balance and even air flow.



CT143B

Universal Dusting Brush

Elongated universal dusting brush will change the way you dust. Features gentle, soft nylon bristles.



CT150B

Deluxe Floor/Rug Tool

Moves from hard surface to carpet without adjustment. Front and rear wheels maintain air flow. Offers extra wide 11" of edge-to-edge cleaning.



CT156B

Hard Surface Floor Tool

This 11-3/4" wide brush is ideal for hard flooring surfaces. Two rows of natural bristles pick up dust. Dual rubber wheels provide balance and even air flow. Swivel neck makes it easy to reach all surface areas.



CT157B

Extra Wide Hard Surface Floor Tool

This 14" wide brush cleans hard flooring surfaces. Two rows of natural bristles pick up dust. Dual rubber wheels provide balance and even air flow. Swivel neck makes it easy to reach all surface areas.



CT158

Turn & Twist Floor Brush

This 13" wide brush is perfect for tile, marble, vinyl, laminate and hardwood floors. Our roller ball swivel design allows you to maneuver into tight spaces and corners and also rotates flat to easily reach under cabinets and furniture.

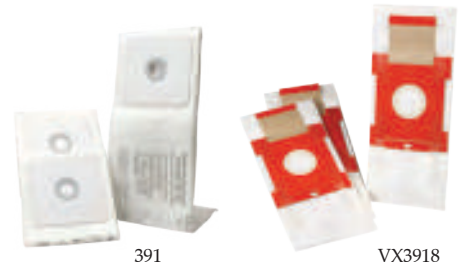

391/CF3918 & VX3916/VX3918

Two-ply electrostatically charged filter media captures particles down to .10 micron at 85% efficiency. Set of three bags. Suggested replacement about twice a year.

Available in two sizes:

Model 391

Six gallon bag – for use with CV350, CV352, CV353, CV400, CV450, CV653 and CV750.

Model CF3918

Eight gallon bag – for CV850, suitable for CV400 and CV750.

Two-ply electrostatically charged media captures particles down to .10 microns at 85% efficiency.

Model VX3916*

Six gallon bag with HEPA® filtration for VX475.

Model VX3918*

Eight gallon bag with HEPA® filtration for VX550.

Model VX3918STD

Eight gallon bag for VX550.

**HEPA® filter media offers the ultimate with 99.97% filtration efficiency and superior air flow with minimum clogging.*

POWERED TO REACH

everywhere you need
to clean.

Our current-carrying hoses bring the power to wherever your vacuum reaches. We offer a wide selection of lightweight, flexible hoses including direct-connect options for use with electrified inlets. Current-carrying hoses allow you to operate an electric power brush without using an additional cord set.

And, the comfortable handle design and fingertip controls on the handle grip add comfort and convenience to your cleaning. The large hose diameter provides better dirt removal. All hoses come with a convenient storage hanger.



CURRENT-CARRYING HOSES



CH615

Direct Connect Lightweight, Crushproof Hose

This lightweight, current-carrying direct-connect hose springs back to retain original shape. Features a 3-position on-off switch. **Available in dark gray.**

- Recommended for use with CI358 and CI390 series electrified inlets
- For use with NuTone CT700 Deluxe Electric Power Brush
- UL approved
- 30' length
- Includes convenient hose hanger to store hose



CH515

Dual-Voltage Lightweight, Crushproof Hose with Pigtail

This lightweight, current-carrying corded hose springs back to retain original shape. Features a 3-position on-off switch and 6' line cord. **Available in dark gray.**

- For use with CT700 Deluxe Electric Power Brush • Includes Universal hose end which fits most other standard inlets
- UL approved
- 30' length
- Includes convenient hose hanger to store hose

HOSE ACCESSORIES



CA130

A knitted hose sock can help prevent scratching corners of walls and marking furniture as you move from room to room while vacuuming.

- Washable
- Treated with ultra fresh antimicrobial protection
- For 30-32' hoses



1. Fit sock over tube end
2. Slide entire sock onto tube
3. Feed nozzle end through tube
4. Slide sock off tube onto hose; zip tie at handle
5. Slide sock off of tube to cover remainder of the hose

HOSE SELECTION CHART

Model No.	Description	Hose Length	Inside Diameter	Power Head Switch	Power Unit Switch	Color
372	Low Voltage Utility/Garage Hose	32'	1-1/4"	No	No	Dark Gray
CH230L	Low Voltage Standard Hose	42'	1-3/8"	No	Yes	Dark Gray
CH235	Crushproof Low Voltage Hose	30'	1-3/8"	No	Yes	Dark Gray
CH515	Current-Carrying Crushproof Hose w/Status Indicator Light	30'	1-1/4"	Yes	Yes	Dark Gray
CH615	Direct-Connect Crushproof Hose w/Status Indicator Light	30'	1-1/4"	Yes	Yes	Dark Gray

HOSE ACCESSORIES

Model No.	Description	Hose Length	Inside Diameter	Color
CA130	Hose Sock	30' -32'	1" & 1-3/8" diameter hoses	Gray

STANDARD INLETS



White

360 Series

Automatic on/off inlets can be installed in walls or floors.

- Size: 3-3/4" w x 3" h x 5/8" d
- Installs with CF361 or CF361F mounting bracket or 395 or 3964 rough-in kits
- Available in white or almond



White

330 Series

Automatic on/off inlets have styrene snap-back protective cover.

- Size: 3" w x 5-3/16" h x 1/2" d
- Install with a CF329 mounting plate or CI3303RK rough-in kits
- Available in white or almond



White

CF372

Utility Inlet

Automatic on/off inlets have styrene snap-back protective cover.

- Size: 2-1/2" w x 2-7/8" h x 1-7/8" d
- Installs directly into exposed piping without the need for brackets or mounting plates



326N

Existing Home Inlet Kit

The Existing Home Inlet Kit assists with installing a central vacuum system after the home construction is complete. Ideal for tight areas where it is difficult to connect straight tubing to wall inlets.

- Includes 330 inlet and 8" length of Superflex tubing
- CF329 Mounting Plate, inlet frame and tubing guard also included

TUBING



3808/3810

Our semi-rigid white PVC tubing has exceptional tensile strength. Lightweight and easy to handle, it can be cut with an ordinary saw. Its self-extinguishing properties will not support combustion making it extremely safe for your home's walls. Installs vertically or horizontally and is not affected by weather – won't rust or deteriorate.

- Conforms to all UL requirements
- Manufactured in conformity with ASTM F2158 and UMC certified
- 2" OD x 8' or 10' lengths

TUBING GUIDE

Number of Inlets	3	4	5	6	7
PVC Tubing Required	48'	64'	80'	100'	120'

FITTINGS

CI3303RK Rough In

for 3-inlet installation includes:

- | | |
|---------------------------------|-----------------------|
| 3 – Mounting Brackets | 6 – Nail Guards |
| 3 – Plaster Guards | 6 – 90° Sweep Ells |
| 6 – Screws for
Plaster Guard | 2 – 45° Ells |
| 3 – 90° Elbows | 3 – 90° Tee Wyes |
| 1 – 90° Street Ell | 6 – Stop Couplings |
| 1 – 45° Street Ell | 1 – Solvent Cement |
| | 1 – 1001 18/2 UL Wire |

Installation Components

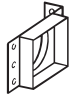

CF361 Mounting Bracket with plaster guard



CF329 Inlet Mounting Plate

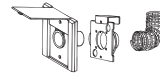

326N Existing Home Inlet Kit



CF369 45° Street Ell



CF361F Mounting Bracket with flanged spigot to assemble to any 382 series elbow



CF362 90° Flanged Ell – standard



376UL 100' Wire 18/2



CF367 Flexible Tubing – 2" ID. x 36" vinyl over steel wire, interwoven with nylon cord, can be cut to any length

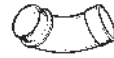

CF368 90° Street Ell



CF382S 90° Sweep Ell for use with Model 329 only for narrow walls



CF377 90° Sweep Ell-long

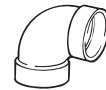

CF382 90° Sweep Ell



CF384 3-Way Ell



CF380 Pipe Support with wire clip

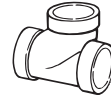

CF383 90° Tee



CF387 45° Wye



CF385 45° Ell



CF389 End Cap

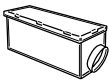

392 Optional Muffler – reduces noise of currently installed power units



CF388 Stop Coupling



394 Blank Cover Plate – white; used in place of wall inlet in speculative rough-in installations



CI324 2" Hose Clamp



393 Metal Wall Cap – terminates exhaust discharge tube to outside

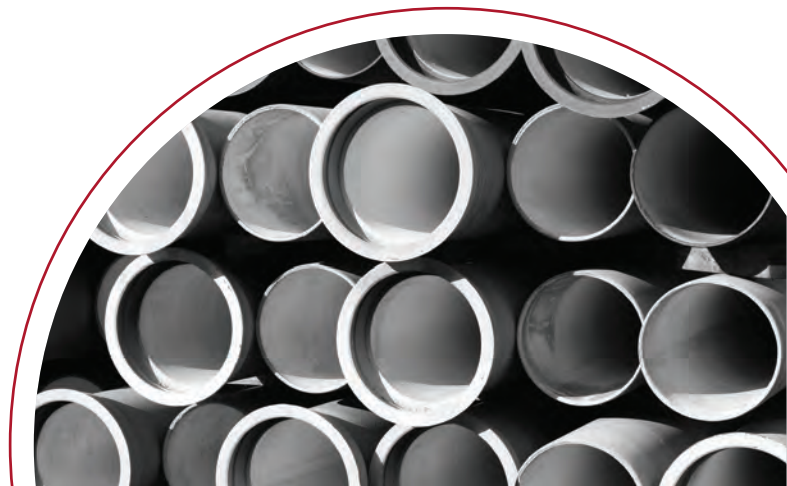

Applications

Villa Application



Apartment Application

I : Laying pipe under the floor

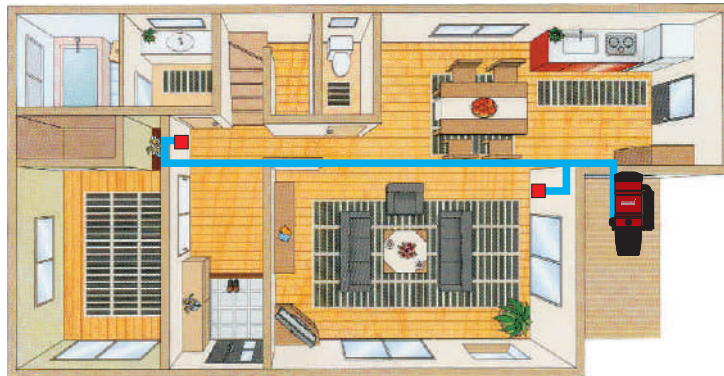

Apartment Application

II : Laying pipe in the ceiling.

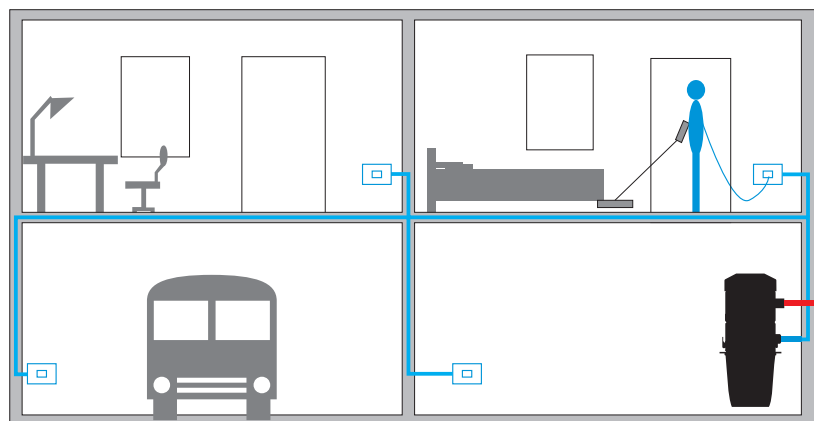
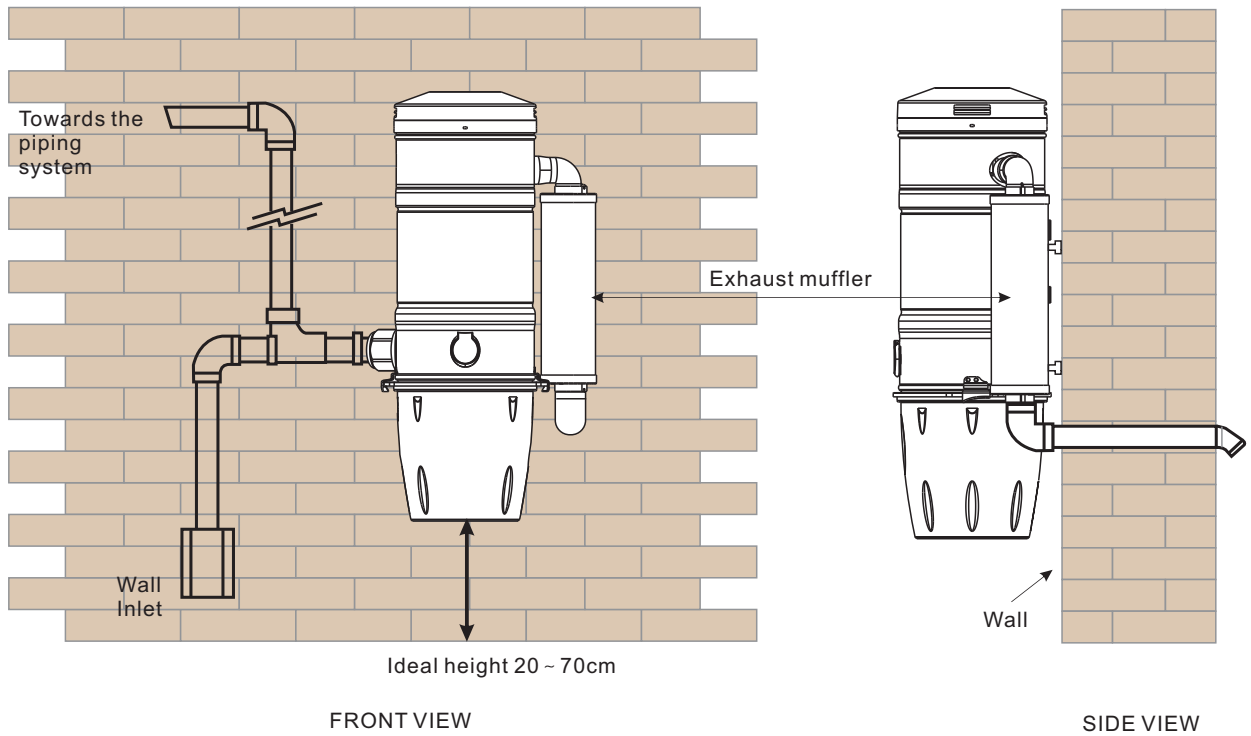
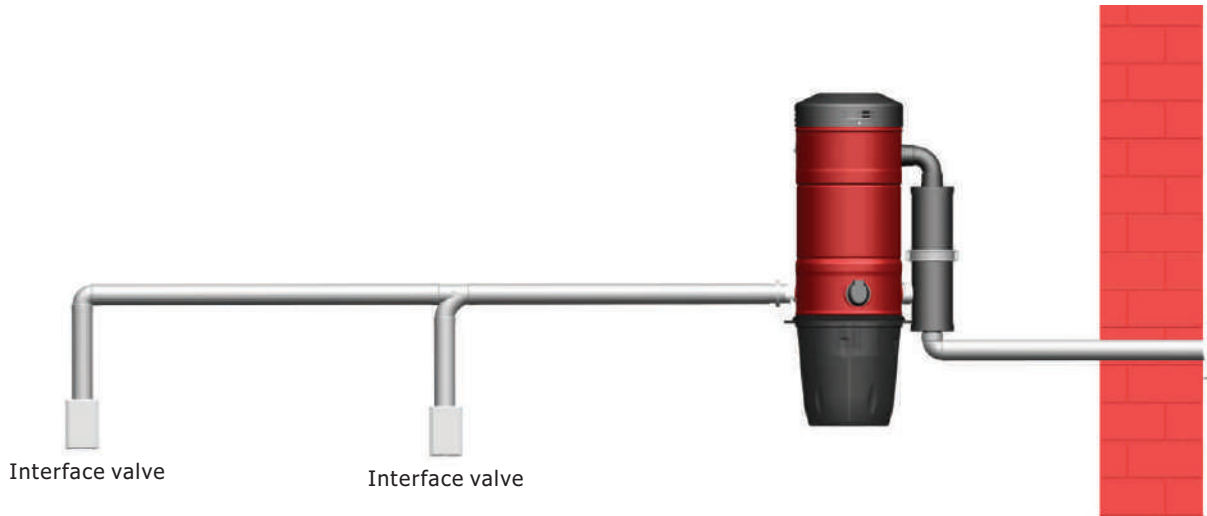

Diagram of System Installation





FTC GLOBALS

Add:1701/C, Al Yasat Tower, Fatima Bint Mubarak Street, Abu Dhabi - U.A.E

<http://www.ftcglobals.com>

E-mail:info@ftcglobals.com / oebid@hotmail.com

Contact: +971 52 508 0488 / +971 55 100 7862

Canada Contact:+1 647 987 5265

